









Model	Description		List
Audio Cables			
Microphone Cable - 2 Core + Shield			

L-2T2S-BK100	6.0mm O/D, Braided Shield - 100m Roll, BLACK		1	\$347.00	Roll
L-2T2S-BL100	6.0mm O/D, Braided Shield - 100m Roll, BLUE		1	\$347.00	Roll
L-2T2S-O100	6.0mm O/D, Braided Shield - 100m Roll, ORANGE		1	\$347.00	Roll
L-2T2S-R100	6.0mm O/D, Braided Shield - 100m Roll, RED		1	\$347.00	Roll
L-2T2S-Y100	6.0mm O/D, Braided Shield - 100m Roll, YELLOW		1	\$347.00	Roll
L-2T2S-GY100	6.0mm O/D, Braided Shield - 100m Roll, GREY		1	\$347.00	Roll
L-2T2S-BK200	6.0mm O/D, Braided Shield - 200m Roll, BLACK		1	\$693.00	Roll
L-2T2S-BL200	6.0mm O/D, Braided Shield - 200m Roll, BLUE		1	\$693.00	Roll
L-2T2S-O200	6.0mm O/D, Braided Shield - 200m Roll, ORANGE		1	\$693.00	Roll
L-2T2S-R200	6.0mm O/D, Braided Shield - 200m Roll, RED		1	\$693.00	Roll
L-2T2S-Y200	6.0mm O/D, Braided Shield - 200m Roll, YELLOW		1	\$693.00	Roll
L-2T2S-GY200	6.0mm O/D, Braided Shield - 200m Roll, GREY		1	\$693.00	Roll
L-2E5-BK200	4.8mm O/D, Braided Shield - 200m Roll, BLACK		1	\$592.00	Roll
L-2E5AT	5.0mm O/D, Braided Shield - 200m Roll, GREY		1	\$395.00	Roll
L-2B2AT	3.1mm OD, Foil Shield - 200m Roll, GREY		1	\$271.00	Roll
L-2B2AT-BK	3.1mm OD, Foil Shield - 200m Roll, BLACK		1	\$271.00	Roll
L-2B2AT-500	3.1mm OD, Foil Shield - 500m Roll, GREY		1	\$676.00	Roll
L-2B2AT-500BK	3.1mm OD, Foil Shield - 500m Roll, BLACK		1	\$676.00	Roll

STARQUAD Mic/Line Cable - 4 Core + Shield			
--	--	--	--

L-4E6S-BK100	6.0mm O/D, STARQUAD w/- Braided Shield - 100m Roll, BLACK		1	\$340.00	Roll	
L-4E6S-BL100	6.0mm O/D, STARQUAD w/- Braided Shield - 100m Roll, BLUE		1	\$340.00	Roll	
L-4E6S-O100	6.0mm O/D, STARQUAD w/- Braided Shield - 100m Roll, ORANGE		1	\$340.00	Roll	
L-4E6S-R100	6.0mm O/D, STARQUAD w/- Braided Shield - 100m Roll, RED		1	\$340.00	Roll	
L-4E6S-Y100	6.0mm O/D, STARQUAD w/- Braided Shield - 100m Roll, YELLOW		1	\$340.00	Roll	
L-4E6S-GY100	6.0mm O/D, STARQUAD w/- Braided Shield - 100m Roll, GREY		1	\$340.00	Roll	
L-4E6S-BR100	6.0mm O/D, STARQUAD w/- Braided Shield - 100m Roll, BROWN		1	\$340.00	Roll	
L-4E6S-G100	6.0mm O/D, STARQUAD w/- Braided Shield - 100m Roll, GREEN		1	\$340.00	Roll	
L-4E6S-P100	6.0mm O/D, STARQUAD w/- Braided Shield - 100m Roll, PURPLE		1	\$340.00	Roll	
L-4E6S-W100	6.0mm O/D, STARQUAD w/- Braided Shield - 100m Roll, WHITE		1	\$340.00	Roll	
L-4E6S-BK200	6.0mm O/D, STARQUAD w/- Braided Shield - 200m Roll, BLACK		1	\$676.00	Roll	
L-4E6S-BL200	6.0mm O/D, STARQUAD w/- Braided Shield - 200m Roll, BLUE		1	\$676.00	Roll	
L-4E6S-O200	6.0mm O/D, STARQUAD w/- Braided Shield - 200m Roll, ORANGE		1	\$676.00	Roll	
L-4E6S-R200	6.0mm O/D, STARQUAD w/- Braided Shield - 200m Roll, RED		1	\$676.00	Roll	
L-4E6S-Y200	6.0mm O/D, STARQUAD w/- Braided Shield - 200m Roll, YELLOW		1	\$676.00	Roll	
L-4E6S-GY200	6.0mm O/D, STARQUAD w/- Braided Shield - 200m Roll, GREY		1	\$676.00	Roll	
L-4E6S-BR200	6.0mm O/D, STARQUAD w/- Braided Shield - 200m Roll, BROWN		1	\$676.00	Roll	
L-4E6S-G200	6.0mm O/D, STARQUAD w/- Braided Shield - 200m Roll, GREEN		1	\$676.00	Roll	
L-4E6S-P200	6.0mm O/D, STARQUAD w/- Braided Shield - 200m Roll, PURPLE		1	\$676.00	Roll	
L-4E6S-W200	6.0mm O/D, STARQUAD w/- Braided Shield - 200m Roll, WHITE		1	\$676.00	Roll	
L-4E5C-BK100	5.0mm OD, Braided Shield - 100m Roll, BLACK (Suits TT Bantams)		1	\$324.00	Roll	
L-4E5AT-100	5.0mm OD, Foil Shield - 100m Roll, GREY			1	\$212.00	Roll
L-4E5AT-200	* 5.0mm OD, Foil Shield - 200m Roll, GREY			1	\$423.00	Roll
L-4E6AT-100	* 5.8mm OD, Foil Shield - 100m Roll, GREY		1	\$271.00	Roll	

Model	Description	List
Instrument Cable - 1 Core + Shield		
GS4-BK200	4 mm O/D w/- Braided Sheild - 200m Roll, BLACK	1 \$676.00 Roll
GS6-BK100	5.8mm O/D w/- Braided Sheild - 100m Roll, BLACK	1 \$648.00 Roll
GS6-BL100	5.8mm O/D w/- Braided Sheild - 100m Roll, BLUE	1 \$648.00 Roll
GS6-O100	5.8mm O/D w/- Braided Sheild - 100m Roll, ORANGE	1 \$648.00 Roll
GS6-R100	5.8mm O/D w/- Braided Sheild - 100m Roll, RED	1 \$648.00 Roll
GS6-Y100	5.8mm O/D w/- Braided Sheild - 100m Roll, YELLOW	1 \$648.00 Roll



Speaker Cable - 4 Conductor		
4S6	6.4mm OD x 100m - GREY	1 \$226.00 Roll
4S6-BK	6.4mm OD x 100m - BLACK	1 \$226.00 Roll
4S8	8.3mm OD x 100m - GREY	1 \$423.00 Roll
4S11	10.7mm OD x 100m - GREY	1 \$845.00 Roll



Digital Audio Cable - 2 Core + Shield		
DA206-BL100	7.3mm O/D w/- Braided Sheild - 100m Roll, BLUE	1 \$648.00 Roll
DA206-BL200	* 7.3mm O/D w/- Braided Sheild - 200m Roll, BLUE	1 \$1,296.00 Roll
DA202-BL100	5.0mm O/D w/- Braided Sheild - 100m Roll, BLUE	1 \$352.00 Roll
DA202-BL200	* 5.0mm O/D w/- Braided Sheild - 200m Roll, BLUE	1 \$704.00 Roll
DA202AT-BL100	4.0mm O/D w/- Foil Sheild - 100m Roll, BLUE	1 \$192.00 Roll
DA202AT-BL200	* 4.0mm O/D w/- Foil Sheild - 200m Roll, BLUE	1 \$383.00 Roll
DA202-2P	** 2-Channel DA202 (Braided Shield) - Per Metre	1 \$18.00 Metre
DA202-2P-100	2-Channel DA202 (Braided Shield) - 100m	1 \$1,800.00 Roll
DA202-4P	** 4-Channel DA202 (Braided Shield) - Per Metre	1 \$29.00 Metre
DA202-4P-100	4-Channel DA202 (Braided Shield) - 100m	1 \$2,900.00 Roll
DA202-8P	** 8-Channel DA202 (Braided Shield) - Per Metre	1 \$53.00 Metre
DA202-8P-100	8-Channel DA202 (Braided Shield) - 100m	1 \$5,300.00 Roll



Multicore Audio Cable: 2-CORE		
MR202-2AT	2 Cond + Insulated Foil Shield - 2 Channel (Black)	1 \$4.00 Metre
MR202-2AT-100	2 Cond + Insulated Foil Shield - 2 Channel (Black) 100m	1 \$400.00 Roll
MR202-4AT	2 Cond + Insulated Foil Shield - 4 Channel (Black)	1 \$8.00 Metre
MR202-4AT-100	2 Cond + Insulated Foil Shield - 4 Channel (Black) 100m	1 \$800.00 Roll
MR202-8AT	2 Cond + Insulated Foil Shield - 8 Channel (Black)	1 \$15.00 Metre
MR202-8AT-100	2 Cond + Insulated Foil Shield - 8 Channel (Black) 100m	1 \$1,500.00 Roll
MR202-12AT	2 Cond + Insulated Foil Shield - 12 Channel (Black)	1 \$24.00 Metre
MR202-12AT-100	2 Cond + Insulated Foil Shield - 12 Channel (Black) 100m	1 \$2,400.00 Roll
MR202-16AT	2 Cond + Insulated Foil Shield - 16 Channel (Black)	1 \$28.00 Metre
MR202-16AT-100	2 Cond + Insulated Foil Shield - 16 Channel (Black) 100m	1 \$2,800.00 Roll
MR202-24AT	2 Cond + Insulated Foil Shield - 24 Channel (Black)	1 \$36.00 Metre
MR202-24AT-100	2 Cond + Insulated Foil Shield - 24 Channel (Black) 100m	1 \$3,600.00 Roll
MR202-32AT	2 Cond + Insulated Foil Shield - 32 Channel (Black)	1 \$52.00 Metre
MR202-32AT-100	2 Cond + Insulated Foil Shield - 32 Channel (Black) 100m	1 \$5,200.00 Roll



Multicore Audio Cable: STARQUAD		
L-4E4-2AT	* STARQUAD, Foil Sheild - 2 Channel (Grey)	1 \$12.00 Metre
L-4E4-2AT-100	STARQUAD, Foil Sheild - 2 Channel (Grey) 100m	1 \$1,200.00 Roll
L-4E4-4AT	* STARQUAD, Foil Sheild - 4 Channel (Grey)	1 \$18.00 Metre
L-4E4-4AT-100	STARQUAD, Foil Sheild - 4 Channel (Grey) 100m	1 \$1,800.00 Roll
L-4E4-8AT	* STARQUAD, Foil Sheild - 8 Channel (Grey)	1 \$25.00 Metre
L-4E4-8AT-100	STARQUAD, Foil Sheild - 8 Channel (Grey) 100m	1 \$2,500.00 Roll
L-4E4-12AT	* STARQUAD, Foil Sheild - 12 Channel (Grey)	1 \$34.00 Metre
L-4E4-12AT-100	STARQUAD, Foil Sheild - 12 Channel (Grey)100m	1 \$3,400.00 Roll
L-4E4-16AT	* STARQUAD, Foil Sheild - 16 Channel (Grey)	1 \$43.00 Metre
L-4E4-16AT-100	STARQUAD, Foil Sheild - 16 Channel (Grey) 100m	1 \$4,300.00 Roll
L-4E4-24AT	* STARQUAD, Foil Sheild - 24 Channel (Grey)	1 \$78.00 Metre
L-4E4-24AT-100	STARQUAD, Foil Sheild - 24 Channel (Grey) 100m	1 \$7,800.00 Roll
L-4E3-2P	* STARQUAD: Braided Shield - 2 Channel (Black)	1 \$13.00 Metre
L-4E3-2P-100	STARQUAD: Braided Shield - 2 Channel (Black) 100m	1 \$1,300.00 Roll
L-4E3-4P	* STARQUAD: Braided Shield - 4 Channel (Black)	1 \$21.00 Metre
L-4E3-4P-100	STARQUAD: Braided Shield - 4 Channel (Black) 100m	1 \$2,100.00 Roll
L-4E3-8P	* STARQUAD: Braided Shield - 8 Channel (Black)	1 \$32.00 Metre
L-4E3-8P-100	STARQUAD: Braided Shield - 8 Channel (Black) 100m	1 \$3,200.00 Roll
L-4E3-12P	* STARQUAD: Braided Shield - 12 Channel (Black)	1 \$43.00 Metre
L-4E3-12P-100	STARQUAD: Braided Shield - 12 Channel (Black) 100m	1 \$4,300.00 Roll
L-4E3-16P	* STARQUAD: Braided Shield - 16 Channel (Black)	1 \$53.00 Metre
L-4E3-16P-100	STARQUAD: Braided Shield - 16 Channel (Black) 100m	1 \$5,300.00 Roll
L-4E3-24P	* STARQUAD: Braided Shield - 24 Channel (Black)	1 \$111.00 Metre
L-4E3-24P-100	STARQUAD: Braided Shield - 24 Channel (Black) 100m	1 \$11,100.00 Roll

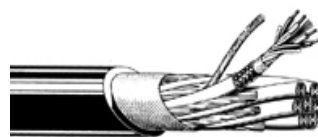

(* = Non-stock item, ** = MOQ's may be applicable)

Model	Description	List
-------	-------------	------

Cable Reels

R300	* Small Reel, Stackable (No Wheels)
R300-L	* R300 with Connector Mtg. Flange
R300-S	* R300 with Hub Cutout & Hanger
R300-CN	* R300L with Male & Female XLR Connectors
R380-S	* Medium Reel with Wheels, Cutout & Hanger
R460-S	* Large Reel with Wheels, Cutout & Hanger



2	\$816.00	<i>Each</i>
2	\$826.00	<i>Each</i>
2	\$902.00	<i>Each</i>
2	\$1,001.00	<i>Each</i>
2	\$1,232.00	<i>Each</i>
2	\$1,292.00	<i>Each</i>

CR100-CN 100M	* R399-CN with 100m L4E6 and XLR3-11 M/F
----------------------	--

2	\$1,476.00	<i>Each</i>
---	-------------------	-------------

Cable Reel / Multicore SYSTEMS

8R30-E3	* 8 CH - 30m with Multipin, L4E3 Type Cable
8R50-E3	* 8 CH - 50m with multipin, L4E3 Type Cable
12R30-E3	* 12 CH - 30m with multipin, L4E3 Type Cable
12R50-E3	* 12 CH - 50m with multipin, L4E3 Type Cable
16R30-E3	* 16 CH - 30m with multipin, L4E3 Type Cable
16R50-E3	* 16 CH - 50m with multipin, L4E3 Type Cable
24R30-E3	* 24 CH - 30m with multipin, L4E3 Type Cable



2	\$2,834.00	<i>Each</i>
2	\$3,376.00	<i>Each</i>
2	\$3,524.00	<i>Each</i>
2	\$4,411.00	<i>Each</i>
2	\$4,140.00	<i>Each</i>
2	\$5,249.00	<i>Each</i>
2	\$6,087.00	<i>Each</i>

Assembled Microphone Cables

L4E6-S "Starquad" Mic. Cable with NEUTRIK XX-B Black/Gold XLR's

EC015-BXX	1.5 Metre Microphone Lead - Black
EC03-BXX	3 Metre Microphone Lead - Black
EC05-BXX	5 Metre Microphone Lead - Black
EC07-BXX	7 Metre Microphone Lead - Black
EC10-BXX	10 Metre Microphone Lead - Black
EC15-BXX	15 Metre Microphone Lead - Black
EC20-BXX	* 20 Metre Microphone Lead - Black



2	\$48.00	<i>Each</i>
2	\$54.00	<i>Each</i>
2	\$62.00	<i>Each</i>
2	\$70.00	<i>Each</i>
2	\$81.00	<i>Each</i>
2	\$101.00	<i>Each</i>
2	\$121.00	<i>Each</i>

Audio Connectors Jack Plugs & RCA Connectors

F-09	RCA Plug
F-10	RCA Plug (Deluxe)
F-11	3.5mm Mini Jack Plug - MONO
F-12	3.5mm Mini Jack Plug - STEREO
F-15	MONO Jack Plug - 6.5mm
F-16	STEREO Jack Plug - 6.5mm

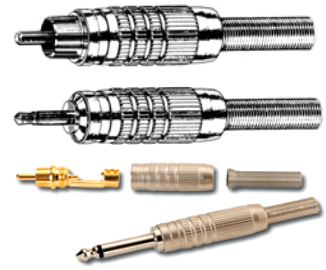

2	\$9.00	<i>Each</i>
2	\$11.00	<i>Each</i>
2	\$12.00	<i>Each</i>
2	\$13.00	<i>Each</i>
2	\$11.00	<i>Each</i>
2	\$12.00	<i>Each</i>

XLR Audio Patch Panels

161U-X1F	1U Panel - 16 x Female XLR
161U-X2F	1U Panel - 16 x Male XLR
161U-X12F	1U Panel - 8 x Male + 8 x Female XLR

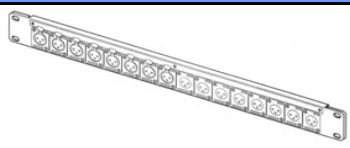



2	\$542.00	<i>Each</i>
2	\$355.00	<i>Each</i>
2	\$426.00	<i>Each</i>

(* = Non-stock item, ** = MOQ's may be applicable)



Model	Description	List
-------	-------------	------

Video Cables

75 Ohm Video Cables



L-3C2VS-BK	Mini-Coax Type, 5.5mm O/D, Flexible Centre Cond, Braided Shield. 100m Roll - BLACK	1	\$215.00	Roll
L-3C2VS-BL	* Mini-Coax Type, 5.5mm O/D, Flexible Centre Cond, Braided Shield. 100m Roll - BLUE	1	\$215.00	Roll
L-3C2VS-G	Mini-Coax Type, 5.5mm O/D, Flexible Centre Cond, Braided Shield. 100m Roll - GREEN	1	\$215.00	Roll
L-3C2VS-R	Mini-Coax Type, 5.5mm O/D, Flexible Centre Cond, Braided Shield. 100m Roll - RED	1	\$215.00	Roll
				
LV-61S-BK	RG59B/U Equiv, 6.1mm O/D, Flexible Centre Cond, heavy Braided Shield. 153 Metre (500') Roll - BLACK	1	\$392.00	Roll
LV-61S-BL	RG59B/U Equiv, 6.1mm O/D, Flexible Centre Cond, heavy Braided Shield. 153 Metre (500') Roll - BLUE	1	\$392.00	Roll
LV-61S-G	RG59B/U Equiv, 6.1mm O/D, Flexible Centre Cond, heavy Braided Shield. 153 Metre (500') Roll - GREY	1	\$392.00	Roll
LV-61S-O	RG59B/U Equiv, 6.1mm O/D, Flexible Centre Cond, heavy Braided Shield. 153 Metre (500') Roll - ORANGE	1	\$392.00	Roll
LV-61S-P	RG59B/U Equiv, 6.1mm O/D, Flexible Centre Cond, heavy Braided Shield. 153 Metre (500') Roll - PURPLE	1	\$392.00	Roll
LV-61S-R	RG59B/U Equiv, 6.1mm O/D, Flexible Centre Cond, heavy Braided Shield. 153 Metre (500') Roll - RED	1	\$392.00	Roll
LV-61S-W	RG59B/U Equiv, 6.1mm O/D, Flexible Centre Cond, heavy Braided Shield. 153 Metre (500') Roll - WHITE	1	\$392.00	Roll
LV-61S-Y	RG59B/U Equiv, 6.1mm O/D, Flexible Centre Cond, heavy Braided Shield. 153 Metre (500') Roll - YELLOW	1	\$392.00	Roll
				
LV-77S-BK	Double Braided Shields with Flexible Stranded Centre Conductor, 7.7mm O/D. 153 Metre (500') Roll - BLACK	1	\$927.00	Roll
LV-77S-BL	Double Braided Shields with Flexible Stranded Centre Conductor, 7.7mm O/D. 153 Metre (500') Roll - BLUE	1	\$927.00	Roll
LV-77S-BR	Double Braided Shields with Flexible Stranded Centre Conductor, 7.7mm O/D. 153 Metre (500') Roll - BROWN	1	\$927.00	Roll
LV-77S-O	Double Braided Shields with Flexible Stranded Centre Conductor, 7.7mm O/D. 153 Metre (500') Roll - ORANGE	1	\$927.00	Roll
LV-77S-G	Double Braided Shields with Flexible Stranded Centre Conductor, 7.7mm O/D. 153 Metre (500') Roll - GREEN	1	\$927.00	Roll
LV-77S-GR	Double Braided Shields with Flexible Stranded Centre Conductor, 7.7mm O/D. 153 Metre (500') Roll - GREY	1	\$927.00	Roll
LV-77S-Y	Double Braided Shields with Flexible Stranded Centre Conductor, 7.7mm O/D. 153 Metre (500') Roll - YELLOW	1	\$927.00	Roll
LV-77S-W	Double Braided Shields with Flexible Stranded Centre Conductor, 7.7mm O/D. 153 Metre (500') Roll - WHITE	1	\$927.00	Roll
LV-77S-P	Double Braided Shields with Flexible Stranded Centre Conductor, 7.7mm O/D. 153 Metre (500') Roll - PURPLE	1	\$927.00	Roll
LV-77S-R	Double Braided Shields with Flexible Stranded Centre Conductor, 7.7mm O/D. 153 Metre (500') Roll - RED	1	\$927.00	Roll

75 Ohm Video Multicore Cable

V3-1.5C	3-Way "Mini-Coax" Video Multicore - 7.4mm O/D (per metre)	1	\$6.00	Metre
V3-1.5C-100	3-Way "Mini-Coax" Video Multicore - 7.4mm O/D (100 metres)	1	\$600.00	Roll
V4-1.5C	4-Way "Mini-Coax" Video Multicore - 8.4mm O/D (per metre)	1	\$8.00	Metre
V4-1.5C-100	4-Way "Mini-Coax" Video Multicore - 8.4mm O/D (100 metres)	1	\$800.00	Roll
V5-1.5C	5-Way "Mini-Coax" Video Multicore - 9.2mm O/D (per metre)	1	\$8.00	Metre
V5-1.5C-100	5-Way "Mini-Coax" Video Multicore - 9.2mm O/D (100 metres)	1	\$800.00	Roll
				
V3-3C	3-Way RG59-Type Video Multicore - 11.5mm O/D (per metre)	1	\$9.00	Metre
V3-3C-100	3-Way RG59-Type Video Multicore - 11.5mm O/D (100 metres)	1	\$900.00	Roll
V4-3C	4-Way RG59-Type Video Multicore - 13.0mm O/D (per metre)	1	\$12.00	Metre
V4-3C-100	4-Way RG59-Type Video Multicore - 13.0mm O/D (100 metres)	1	\$1,200.00	Roll
V5-3C	5-Way RG59-Type Video Multicore - 14.2mm O/D (per metre)	1	\$14.00	Metre
V5-3C-100	5-Way RG59-Type Video Multicore - 14.2mm O/D (100 metres)	1	\$1,400.00	Roll
V6-3C-SC	6-Way RG59-Type Video Multicore - 15.7mm O/D (per metre) *SPECIAL*	1	\$24.00	Metre
V6-3C-SC-100	6-Way RG59-Type Video Multicore - 15.7mm O/D (100 metres) *SPECIAL*	1	\$2,400.00	Roll
				
V3-5C	3-Way Heavy-Duty Video Multicore - 15.5mm O/D (per metre)	1	\$13.00	Metre
V3-5C-100	3-Way Heavy-Duty Video Multicore - 15.5mm O/D (100 metres)	1	\$1,300.00	Roll
V4-5C	4-Way Heavy-Duty Video Multicore - 17.1mm O/D (per metre)	1	\$16.00	Metre
V4-5C-100	4-Way Heavy-Duty Video Multicore - 17.1mm O/D (100 metres)	1	\$1,600.00	Roll
V5-5C	5-Way Heavy-Duty Video Multicore - 19.2mm O/D (per metre)	1	\$20.00	Metre
V5-5C-100	5-Way Heavy-Duty Video Multicore - 19.2mm O/D (100 metres)	1	\$2,000.00	Roll
				

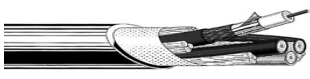

Serial Digital Video Cables

L-2.5CFB-BK100 **	Mini-Coax Type, 4.0mm O/D, Solid Centre Conductor, Double Shields: Foil + Braided (>92% Coverage). 100m Roll - BLACK	1	\$172.00	Roll
L-2.5CFB-BK200		1	\$344.00	Roll
L-3CFB-BK100 *	Mini-Coax Type, 5.5mm O/D, Solid Centre Conductor, Double Shields: Foil + Braided (>92% Coverage). 100m Roll - BLACK	1	\$198.00	Roll
LS-3CFB-BK100 *	Mini-Coax Type, 5.5mm O/D Lighter >71% Outer Shield	1	\$175.00	Roll
L-4CFB-BK100	RG59-Type, 6.1mm O/D, Solid Centre Conductor, Double-Shields: Inner Foil + Outer Braided Shield (>92% Coverage). 100m Roll - BLACK	1	\$231.00	Roll
L-4CFB-BK200	RG59-Type, 6.1mm O/D 200m Roll	1	\$462.00	Roll
L-4CFBS-BK200	RG59-Type, 6.1mm O/D, Solid Centre Conductor, Cardboard Spool 200m Roll	1	\$490.00	Roll
LS-4CFB-BK100 *	RG59-Type, 6.1mm O/D, Solid Centre Conductor, Lighter >71% Outer Shield	1	\$195.00	Roll
L-5CFB-BK100	RG6-Type, 7.5mm O/D, Solid Centre Conductor, Double-Shields: Inner Foil + Outer Braided Shield (>92% Coverage). 100m Roll - BLACK	1	\$313.00	Roll
LS-5CFB-BK100 *	RG6-Type, 7.5mm O/D, Solid Centre Conductor : Lighter >71% Outer Shield	1	\$265.00	Roll
L-7CFB-BK100 *	RG11-Type, 10.2mm O/D, Solid Centre Conductor, Double-Shields: Inner Foil + Outer Braided Shield (>92% Coverage). 100m Roll - BLACK	1	\$676.00	Roll

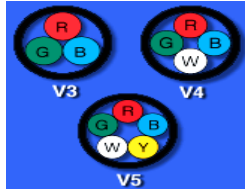
Model	Description		List	
V3-3CFB	* 3-Way 3CFB Mini SDV Multicore - 11.5mm O/D (Per Metre)		1	\$11.00 Metre
V3-3CFB-100	3-Way 3CFB Mini SDV Multicore - 11.5mm O/D (100 metres)		1	\$1,100.00 Roll
V4-3CFB	** 4-Way 3CFB Mini SDV Multicore - 13.0mm O/D (Per Metre)		1	\$13.00 Metre
V4-3CFB-100	4-Way 3CFB Mini SDV Multicore - 13.0mm O/D (100 metres)		1	\$1,300.00 Roll
V5-3CFB	* 5-Way 3CFB Mini SDV Multicore - 14.2mm O/D (Per Metre)		1	\$15.00 Metre
V5-3CFB-100	5-Way 3CFB Mini SDV Multicore - 14.2mm O/D (100 metres)	1	\$1,500.00 Roll	
V3-4CFB	** 3-Way 4CFB (RG59) SDV Multicore - 12.9mm O/D (Per Metre)		1	\$12.00 Metre
V3-4CFB-100	3-Way 4CFB (RG59) SDV Multicore - 12.9mm O/D (100 metres)		1	\$1,200.00 Roll
V4-4CFB	** 4-Way 4CFB (RG59) SDV Multicore - 14.4mm O/D (Per Metre)		1	\$16.00 Metre
V4-4CFB-100	4-Way 4CFB (RG59) SDV Multicore - 14.4mm O/D (100 metres)		1	\$1,600.00 Roll
V5-4CFB	** 5-Way 4CFB (RG59) SDV Multicore - 16.1mm O/D (Per Metre)		1	\$19.00 Metre
V5-4CFB-100	5-Way 4CFB (RG59) SDV Multicore - 16.1mm O/D (100 metres)	1	\$1,900.00 Roll	
V3-5CFB	* 3-Way 5CFB (RG6) SDV Multicore - 17.1mm O/D (Per Metre)		1	\$14.00 Metre
V3-5CFB-100	3-Way 5CFB (RG6) SDV Multicore - 17.1mm O/D (100 metres)		1	\$1,400.00 Roll
V4-5CFB	* 4-Way 5CFB (RG6) SDV Multicore - 18.8mm O/D (Per Metre)		1	\$20.00 Metre
V4-5CFB-100	4-Way 5CFB (RG6) SDV Multicore - 18.8mm O/D (100 metres)		1	\$2,000.00 Roll
V5-5CFB	* 5-Way 5CFB (RG6) SDV Multicore - 21.1mm O/D (Per Metre)		1	\$22.00 Metre
V5-5CFB-100	5-Way 5CFB (RG6) SDV Multicore - 21.1mm O/D (100 metres)	1	\$2,200.00 Roll	



A2 Series Video/Audio Cable

A2V1	1 Video + 2 Audio Channels (L2B2AT Foil Shield) - per metre		2	\$10.00 Metre
A2V1B	* 1Video + 2 Audio Channels (L4E3 Braided Shield) - per metre		2	\$16.00 Metre
A2V2-L	2 Video + 2 Audio (L2B2AT Foil Shield) + 4 CONTROL - per metre		2	\$13.00 Metre
A2V2B	* 2 Video + 2 Audio (L4E3 Braided Shield) + 4 CONTROL - per metre		2	\$19.00 Metre

Video Fantails



(1, 2, 8 & 10m Also Available - POA)

3VS03-3C	* V-Series Cable + BCP-C3 - 3 CH x 3 m		2	\$95.00 Each
3VS05-3C	* V-Series Cable + BCP-C3 - 3 CH x 5 m		2	\$113.00 Each
4VS03-3C	* V-Series Cable + BCP-C3 - 4 CH x 3 m		2	\$124.00 Each
4VS05-3C	* V-Series Cable + BCP-C3 - 4 CH x 5 m		2	\$148.00 Each
5VS03-3C	* V-Series Cable + BCP-C3 - 5 CH x 3 m		2	\$153.00 Each
5VS05-3C	* V-Series Cable + BCP-C3 - 5 CH x 5 m		2	\$180.00 Each

In-Line Impedance Transformers

BCJ-XP-TRB	110Ω / 75Ω Impedance Transformer (Male XLR to BNC)		2	\$61.00 Each
BCJ-XJ-TRB	110Ω / 75Ω Impedance Transformer (Female XLR to BNC)		2	\$61.00 Each
BCJ-XJ-A10TRA	110Ω / 75Ω Impedance Transformer With 10dB Pad		2	\$97.00 Each

Panel-Mount Impedance Transformers

XJ3M-TRB-BCJ	110Ω / 75Ω Impedance Transformer (Male XLR Panel to BNC)		2	\$101.00 Each
XJ3F-TRB-BCJ	110Ω / 75Ω Impedance Transformer (Female XLR Panel to BNC)		2	\$138.00 Each
XJ3F-A10TRA-BCJ	XJ3F-TRB-BCJ With 10dB Pad		2	\$176.00 Each
BCJ-TRB-XP3M	110Ω / 75Ω Impedance Transformer (BNC Panel to Male XLR Line)		2	\$101.00 Each
BCJ-TRB-XP3F	110/75 Ohm Impedance Transformer (BNC Panel to Female XLR Line)		2	\$116.00 Each
BCJ-A10TRA-XP3F	BCJ-TRB-XP3F with 10dB Pad		2	\$147.00 Each

Model	Description	List
Video Connectors & Accessories		
PC-Series 75Ω BNC Line Connectors (crimp-type)		

BCP-PC3	Suits L-3C2VS, V*-3C, A2V1 & A2V2	2	\$6.00	Each
BCP-PC3F	Suits L-3CFB & LS-3CFB, V*-3CFB	2	\$6.00	Each
BCP-PC4	Suits LV-61S (RG59), 8241, 8279	2	\$6.00	Each
BCP-PC4F	Suits 4CF & 4CFB Series, 1505A, 8212, 9259, 9659	2	\$6.00	Each
BCP-PC5	Suits V*-5C Series	2	\$6.00	Each
BCP-PC5F	Suits L-5CFB, LS-5CFB, V*-5CFB Series	2	\$6.00	Each

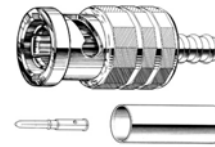

C-Series Precision 75Ω BNC Line Connectors (crimp-type)				
BCP-C1	Suits V*-1.5C, 83264, 83267	2	\$9.00	Each
BCP-C25F	Suits L-2.5CFB, 1417B, 1418B, 8218 & 1855A	2	\$10.00	Each
BCP-C25HDA	Suits L-2.5CHD	2	\$7.00	Each
BCP-C3B	Suits L-3C2VS, V*-3C, A2V1 & A2V2	2	\$7.00	Each
BCP-C3F	* Suits L-3CFB & LS-3CFB, V*-3CFB	2	\$7.00	Each
BCP-C4B	Suits LV-61S (RG59), 8241, 8279	2	\$7.00	Each
BCP-C4F	Suits 4CF & 4CFB Series, 1505A, 8212, 9259, 9659	2	\$7.00	Each
BCP-C5B	Suits V*-5C Series	2	\$7.00	Each
BCP-C5HD	Suits L-5CHD	2	\$14.00	Each
BCP-C5FA	Suits L-5CFB, LS-5CFB, V*-5CFB, 1189A	2	\$7.00	Each
BCP-6HD	Suits L-6CHD	2	\$21.00	Each
BCP-C7FA	* Suits L-7CFB (10.2mm OD)	2	\$17.00	Each
BCP-C77A	* Suits LV-77S (7.7mm OD), 8281F	2	\$8.00	Each
BCP-C7HD	Suits L7CHD	2	\$17.00	Each



MBCP-C Series 75 ohm Slim BNC Crimp Plug				
MBCP-C25F	Suits L-2.5CFB, 1855A	2	\$13.00	Each
MBCP-C3F	Suits L-3CFB	2	\$12.00	Each
MBCP-C4	Suits LV-61S, RG59B/U	2	\$12.00	Each
MBCP-C4F	Suits L-4CFB, 1505A	2	\$12.00	Each
MBCP-C53F	Suits 1694A, 9066	2	\$13.00	Each
MBCP-C5F	Suits L-5CFB, 1189A	2	\$12.00	Each



Coloured Boots For 75Ω BNC's				
CB01-B	Coloured Boot For BCP-C1 - BLUE	2	\$0.90	Each
CB01-BK	Coloured Boot For BCP-C1 - BLACK	2	\$0.90	Each
CB01-G	Coloured Boot For BCP-C1 - GREEN	2	\$0.90	Each
CB01-R	Coloured Boot For BCP-C1 - RED	2	\$0.90	Each
CB01-W	Coloured Boot For BCP-C1 - WHITE	2	\$0.90	Each
CB01-Y	Coloured Boot For BCP-C1 - YELLOW	2	\$0.90	Each
CB03-BK	Coloured Boot For BCP-C3B / PC3 - BLACK	2	\$0.90	Each
CB03-BL	Coloured Boot For BCP-C3B / PC3 - BLUE	2	\$0.90	Each
CB03-BR	Coloured Boot For BCP-C3B / PC3 - BROWN	2	\$0.90	Each
CB03-G	Coloured Boot For BCP-C3B / PC3 - GREEN	2	\$0.90	Each
CB03-GR	Coloured Boot For BCP-C3B / PC3 - GREY	2	\$0.90	Each
CB03-O	Coloured Boot For BCP-C3B / PC3 - ORANGE	2	\$0.90	Each
CB03-P	Coloured Boot For BCP-C3B / PC3 - PURPLE	2	\$0.90	Each
CB03-R	Coloured Boot For BCP-C3B / PC3 - RED	2	\$0.90	Each
CB03-W	Coloured Boot For BCP-C3B / PC3 - WHITE	2	\$0.90	Each
CB03-Y	Coloured Boot For BCP-C3B / PC3 - YELLOW	2	\$0.90	Each
CB04-BK	Coloured Boot For BCP-C4B / C4F / PC4 / PC4F - BLACK	2	\$0.90	Each
CB04-BL	Coloured Boot For BCP-C4B / C4F / PC4 / PC4F - BLUE	2	\$0.90	Each
CB04-BR	Coloured Boot For BCP-C4B / C4F / PC4 / PC4F - BROWN	2	\$0.90	Each
CB04-G	Coloured Boot For BCP-C4B / C4F / PC4 / PC4F - GREEN	2	\$0.90	Each
CB04-GR	Coloured Boot For BCP-C4B / C4F / PC4 / PC4F - GREY	2	\$0.90	Each
CB04-O	Coloured Boot For BCP-C4B / C4F / PC4 / PC4F - ORANGE	2	\$0.90	Each
CB04-P	Coloured Boot For BCP-C4B / C4F / PC4 / PC4F - PURPLE	2	\$0.90	Each
CB04-R	Coloured Boot For BCP-C4B / C4F / PC4 / PC4F - RED	2	\$0.90	Each
CB04-W	Coloured Boot For BCP-C4B / C4F / PC4 / PC4F - WHITE	2	\$0.90	Each
CB04-Y	Coloured Boot For BCP-C4B / C4F / PC4 / PC4F - YELLOW	2	\$0.90	Each
CB05A-BK	Coloured Boot For BCP-C5FA / PC5F - BLACK	2	\$0.90	Each
CB05A-BL	Coloured Boot For BCP-C5FA / PC5F - BLUE	2	\$0.90	Each
CB05A-BR	Coloured Boot For BCP-C5FA / PC5F - BROWN	2	\$0.90	Each
CB05A-G	Coloured Boot For BCP-C5FA / PC5F - GREEN	2	\$0.90	Each
CB05A-GR	Coloured Boot For BCP-C5FA / PC5F - GREY	2	\$0.90	Each
CB05A-O	Coloured Boot For BCP-C5FA / PC5F - ORANGE	2	\$0.90	Each
CB05A-P	Coloured Boot For BCP-C5FA / PC5F - PURPLE	2	\$0.90	Each
CB05A-R	Coloured Boot For BCP-C5FA / PC5F - RED	2	\$0.90	Each
CB05A-W	Coloured Boot For BCP-C5FA / PC5F - WHITE	2	\$0.90	Each
CB05A-Y	Coloured Boot For BCP-C5FA / PC5F - YELLOW	2	\$0.90	Each

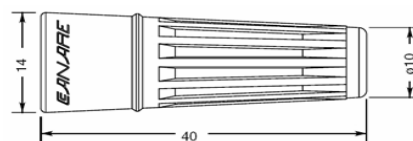
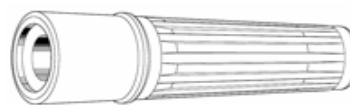
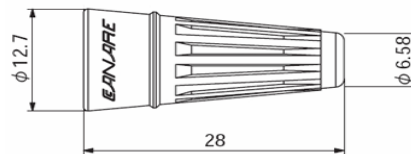

(* = Non-stock item, ** = MOQ's may be applicable)

Model	Description		List
CB24-BK	Coloured Boot For MBCP-C3F- BLACK	2	\$0.90 Each
CB24-BL	Coloured Boot For MBCP-C3F - BLUE	2	\$0.90 Each
CB24-G	Coloured Boot For MBCP-C3F - GREEN	2	\$0.90 Each
CB24-R	Coloured Boot For MBCP-C3F - RED	2	\$0.90 Each
CB24-W	Coloured Boot For MBCP-C3F - WHITE	2	\$0.90 Each
CB24-Y	Coloured Boot For MBCP-C3F - YELLOW	2	\$0.90 Each

CB25-BK	Coloured Boot For MBCP-C4, C4F, C53 - BLACK	2	\$0.90 Each
CB25-BL	Coloured Boot For MBCP-C4, C4F, C53 - BLUE	2	\$0.90 Each
CB25-G	Coloured Boot For MBCP-C4, C4F, C53 - GREEN	2	\$0.90 Each
CB25-R	Coloured Boot For MBCP-C4, C4F, C53 - RED	2	\$0.90 Each
CB25-W	Coloured Boot For MBCP-C4, C4F, C53 - WHITE	2	\$0.90 Each
CB25-Y	Coloured Boot For MBCP-C4, C4F, C53 - YELLOW	2	\$0.90 Each



CB26-BK	Coloured Boot For MBCP-C5F- BLACK	2	\$0.90 Each
CB26-BL	Coloured Boot For MBCP-C5F - BLUE	2	\$0.90 Each
CB26-G	Coloured Boot For MBCP-C5F - GREEN	2	\$0.90 Each
CB26-R	Coloured Boot For MBCP-C5F - RED	2	\$0.90 Each
CB26-W	Coloured Boot For MBCP-C5F - WHITE	2	\$0.90 Each
CB26-Y	Coloured Boot For MBCP-C5F - YELLOW	2	\$0.90 Each



Center Pins for BCP Series

B11014E	Center Pins to suit BCP-C3B (Pack of 100)	2	\$78.00 Each
B11015E	Center Pins to suit BCP-C4B (Pack of 100)	2	\$83.00 Each
B11016E	Center Pins to suit PC5/C5B/C5A (Pack of 100)	2	\$78.00 Each
B11020C	Center Pins to suit (DIGITAL) (Pack of 100)	2	\$88.00 Each

Sleeves

BN7003A	Sleeve to suit C3 SERIES (Pack of 100)	2	\$78.00 Each
BN7015A	Sleeve to suit C4/C4F SERIES (Pack of 100)	2	\$78.00 Each
BN7016	Sleeve to suit C5 SERIES (Pack of 100)	2	\$78.00 Each
BN7029	Sleeve to suit MBCP-C25F (Pack of 100)	2	\$158.00 Each
BN7046	Sleeve to suit MBCP-C53 (Pack of 100)	2	\$136.00 Each

75Ω BNC Terminators & Joiners

BCP-PT	Standard 75Ω BNC TERMINATOR	2	\$10.00 Each
BCP-TA	Precision 75Ω BNC TERMINATOR	2	\$14.00 Each
BCJ-J	Double-Female Precision 75Ω BNC Joiner	2	\$9.00 Each

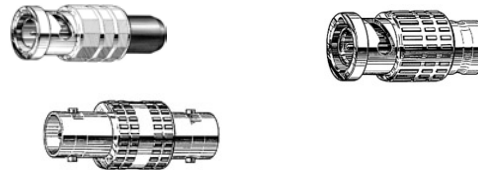

Precision 75Ω RCA Panel Connectors

BCJ-R/1	Female Bulkhead-Mount - Solder Pin With Earth Lug	2	\$12.00 Each
BCJ-JR	Female / Female Bulkhead-Mount	2	\$9.00 Each
BCJ-RU	Recessed Female Panel-Mount - Solder Pin	2	\$15.00 Each
BCJ-JRUD	Recessed Female Panel-Mount - Solder Pin D-SIZE shell	2	\$15.00 Each
BCJ-RUDB	* Recessed Female Panel-Mount - Solder Pin D-SIZE BLACK shell	2	\$19.00 Each
BCJ-JRU	Recessed Female / Female Panel-Mount	2	\$12.00 Each
BCJ-JRUD	Recessed Female / Female Panel-Mount D-SIZE shell	2	\$13.00 Each
BCJ-JRUDB	* Recessed Female / Female Panel-Mount BLACK shell	2	\$17.00 Each
IU-7/16	Isolation Washer - White ABS (Pack of 20)	2	\$8.00 Each
BCJ-DC	* Dust Cap For BNC Receptacles (Pack of 20)	2	\$7.00 Each

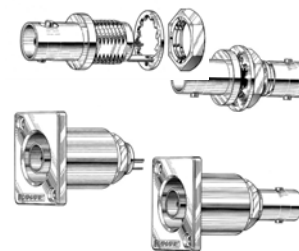

Precision 75Ω RCA Panel Connectors

RCAP-C3A	Suits L-3C2VS, V*-3C, A2V1 & A2V2	2	\$11.00 Each
RCAP-C3F	Suits L-3CFB & LS-3CFB, V*-3CFB	2	\$11.00 Each
RCAP-C4A	Suits LV-61S(RG59), 8241, 8279	2	\$11.00 Each
RCAP-C4F	Suits 4CF & 4CFB Series, 1505A, 1506A, 8212, 9259, 9659	2	\$11.00 Each
RCAP-C5A	Suits V*-5C Series	2	\$10.00 Each
RCAP-C5F	* Suits L-5CFB, LS-5CFB, V*-5CFB, 1189A	2	\$11.00 Each
RCAP-C3GS	Special Audio Version to suit GS-6 Line / Inst Cable	2	\$12.00 Each
CB24-BK	* Coloured Boot For RCAP-C3 - BLACK	2	\$0.90 Each
CB24-BL	Coloured Boot For RCAP-C3 - BLUE	2	\$0.90 Each
CB24-G	Coloured Boot For RCAP-C3 - GREEN	2	\$0.90 Each
CB24-R	Coloured Boot For RCAP-C3 - RED	2	\$0.90 Each
CB24-W	Coloured Boot For RCAP-C3 - WHITE	2	\$0.90 Each
CB24-Y	Coloured Boot For RCAP-C3 - YELLOW	2	\$0.90 Each



Model	Description	List
CB25-BK	* Coloured Boot For RCAP-C4 - BLACK	2 \$0.90 Each
CB25-BL	Coloured Boot For RCAP-C4 - BLUE	2 \$0.90 Each
CB25-G	Coloured Boot For RCAP-C4 - GREEN	2 \$0.90 Each
CB25-R	Coloured Boot For RCAP-C4 - RED	2 \$0.90 Each
CB25-W	Coloured Boot For RCAP-C4 - WHITE	2 \$0.90 Each
CB25-Y	Coloured Boot For RCAP-C4 - YELLOW	2 \$0.90 Each
CB26-BK	* Coloured Boot For RCAP-C5 - BLACK	2 \$0.90 Each
CB26-BL	* Coloured Boot For RCAP-C5 - BLACK	2 \$0.90 Each
CB26-G	* Coloured Boot For RCAP-C5 - BLACK	2 \$0.90 Each
CB26-R	* Coloured Boot For RCAP-C5 - BLACK	2 \$0.90 Each
CB26-W	* Coloured Boot For RCAP-C5 - BLACK	2 \$0.90 Each
CB26-Y	* Coloured Boot For RCAP-C5 - BLACK	2 \$0.90 Each

Precision 75Ω RCA Panel Connectors

RJ-RU-BL	Recessed RCA Receptacle - Solder Type: Blue	2 \$17.00 Each
RJ-RU-G	Recessed RCA Receptacle - Solder Type: Green	2 \$17.00 Each
RJ-RU-R	Recessed RCA Receptacle - Solder Type: Red	2 \$17.00 Each
RJ-RU-W	Recessed RCA Receptacle - Solder Type: White	2 \$17.00 Each
RJ-RU-Y	Recessed RCA Receptacle - Solder Type: Yellow	2 \$17.00 Each
RJ-RUD	Recessed RCA Receptacle - Solder Type D-SIZE shell	2 \$17.00 Each
RJ-RUDB	* Recessed RCA Receptacle - Solder Type D-SIZE BLACK shell	2 \$21.00 Each
RJ-BCJRJ**	Recessed RCA Receptacle to REAR BNC Connector	2 \$24.00 Each
RJ-BCJRUD	Recessed RCA Receptacle to REAR BNC Connector D-SIZE shell	2 \$21.00 Each
RJ-BCJRUDB	* Recessed RCA Receptacle to REAR BNC Connector D-SIZE BLACK shell	2 \$25.00 Each



Precision 75Ω F-Type Line Connectors (crimp)

FP-C3	Suits A2V Series, L-3C2VS, V*-3C Series	2 \$5.00 Each
FP-C3F	* Suits L-3CFB & LS-3CFB, V*-3CFB	2 \$5.00 Each
FP-C4	Suits LV-61S(RG59), 8241, 8279	2 \$5.00 Each
FP-C4F	* Suits 4CF & 4CFB Series, 1505A, 1506A, 8212, 9259, 9659	2 \$5.00 Each
FP-C5	Suits V*-5C Series	2 \$5.00 Each
FP-C5F	* Suits L-5CFB, LS-5CFB, V*-5CFB, 1189A	2 \$5.00 Each



Precision 75Ω F-Type Panel Receptacles

FJ-JR	* Bulkhead-Mount Receptacle - Jack to Jack	2 \$18.00 Each
FJ-JRU	* Bulkhead-Mount Receptacle - Jack to Jack Flush-Mount / Recessed Type	2 \$21.00 Each
FJ-JRUD	* Recessed Double Jack/Jack - D-SIZE Shell	2 \$20.00 Each
FJ-JRUDB	* Recessed Double Jack/Jack - D-SIZE Shell BLACK	2 \$25.00 Each

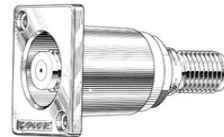

Multi-Channel 75Ω Video Connectors



MCM-V5C3	5-Way LINE Connector (Male) - for V*-C3 Cables	2 \$163.00 Each
DCM-01	Dust Cap for MCM-V5C3 Line Connector	2 \$22.00 Each
MCF-V5C3	5-Way Panel-Mount Receptacle (Female) - V*-C3 & L3C2V	2 \$168.00 Each
DCF-01	Dust Cap for MCF-V5C3 Panel-Mout Connector	2 \$23.00 Each



75 Ohm TRIAXIAL Video Cable

L-5CFTX-BK100	75 ohm TRIAX Cable: 8.8mm O/D, 100m Roll - BLACK. Price Per Metre - also available in Red & Green (special order only, min qty may apply)	2 \$12.00 Metre
---------------	---	-----------------





Model	Description		List
Precision 75Ω TRIAX Connectors (**Crimp-Type**)			
<i>Fischer-compatible, Suitable for 8.8mm Cables such as Canare L-5CFTX & Belden 7783A</i>			
CCM5-PFC CB32	Male Cable Mount (without boot & dust cap) - Suits L-5CFTX Triax Cable		2 \$288.00 <i>Each</i>
	Cable Boot & Dust Cap for CCM5-PFC Male Cable Mount Connector		2 \$62.00 <i>Each</i>
CCF5-JFC CB31	Female Cable Mount (without boot & dust cap) - Suits L-5CFTX Triax Cable		2 \$226.00 <i>Each</i>
	Cable Boot & Dust Cap for CCF5-JF Female Cable Mount Connector		2 \$62.00 <i>Each</i>
CCM5-PFRC DCM02	Male Panel Mount (without dust cap) - Suits L-5CFTX Triax Cable		2 \$398.00 <i>Each</i>
	Dust Cap for CCM5-PFR Male Panel Mount Receptacle		2 \$30.00 <i>Each</i>
CCF5-JFRC DCF02	Female Panel Mount (without dust cap) - Suits L-5CFTX Triax Cable		2 \$302.00 <i>Each</i>
	Dust Cap for CCF5-JFR Female Panel Mount Receptacle		2 \$30.00 <i>Each</i>

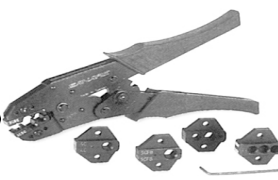





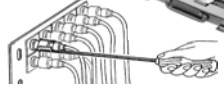
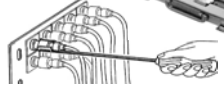



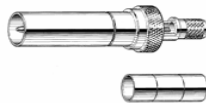

Crimping Tools & Die Sets

TC-1	HAND CRIMP-TOOL (*Without Die Set*)		2 \$207.00 <i>Each</i>
TCD-1DB	Die Set to suit: BCP-C1		2 \$345.00 <i>Each</i>
TCD-35D	Die Set to suit: RCAP-C3GS		2 \$385.00 <i>Each</i>
TCD-35CA	Dies: BCP-C3B/F, C5B/FA, C25F, PC3/3F, PC5/5F, FP-C3/3F/C5, RCAP-C3A/3F/5A		2 \$254.00 <i>Each</i>
TCD-4CA	Die Set to suit: BCP-C4F/C4B, PC4/4F, FP-C4/4F, RCAP-C4A/4F, VWP-C4A		2 \$405.00 <i>Each</i>
TCD-5CF	Die Set to suit: BCP-C5FA, BCP-C77A, FP-C5F, RCAP-C5F		2 \$173.00 <i>Each</i>
TCD-65C	TCD-65C Die Set to suit CC*F-Series Triax Connectors		2 \$592.00 <i>Each</i>

Connector Accessories & Tools

TB-2	CARRY CASE - Holds TS-100E Stripper, Crimp Tool, Die Sets & BNC's		2 \$133.00 <i>Each</i>
TS-100E	Cable Stripper / Preparation Tool For MOST Canare Co-Ax Video Cables & Other Brands With O/D From 4mm to 11mm.		2 \$193.00 <i>Each</i>
TSC	Replacement Blade (single) for TS-100E Stripper		2 \$19.00 <i>Each</i>
BET-12	BNC Extraction Tool		2 \$146.00 <i>Each</i>

Video Patchbays & Cables

MDVJ-STW	Mid-Sized Dual Video Jack - Normal Through		2 \$74.00 <i>Each</i>
MDVJ-STS	Mid-Sized Dual Video Jack - Straight Through		2 \$74.00 <i>Each</i>
DVJB-W	Dual 75 Ohm Video/BNC Jack - Normal Thru		2 \$59.00 <i>Each</i>
DVJB-S	* Dual 75 Ohm Video/BNC Jack - Straight Thru		2 \$59.00 <i>Each</i>
VJ-DC	* Dust Cap For Dual Video Jacks (Pack of 40)		2 \$16.00 <i>Pack</i>
VWP-C4A	Video Patch Plug - Crimp Type For LV61S/RG59U		2 \$10.00 <i>Each</i>
BCJ-VWP	Video Patch Plug / BNC CONVERTER		2 \$20.00 <i>Each</i>
LP1-BK	Video Patch Looping Plug - Black Cable		2 \$84.00 <i>Each</i>
20DV	Video Patchbay - 1U Panel With 20 x DVJB-W Dual Jacks		2 \$1,521.00 <i>Each</i>
20DVS	* Video Patchbay - 1U Panel With 20 x DVJB-S Dual Jacks		2 \$1,521.00 <i>Each</i>
24DV	Video Patchbay - 1U Panel With 24 x DVJB-W Dual Jacks		2 \$1,750.00 <i>Each</i>
24DVS	* Video Patchbay - 1U Panel With 24 x DVJB-S Dual Jacks		2 \$1,750.00 <i>Each</i>
26DV	Video Patchbay - 1U Panel With 26 x DVJB-W Dual Jacks		2 \$1,860.00 <i>Each</i>
26DVS	* Video Patchbay - 1U Panel With 26 x DVJB-S Dual Jacks		2 \$1,860.00 <i>Each</i>
20DV-2U	Video Patchbay - 2U Panel With 20 x DVJB-W Dual Jacks		2 \$1,660.00 <i>Each</i>
20DVS-2U	* Video Patchbay - 2U Panel With 20 x DVJB-S Dual Jacks		2 \$1,660.00 <i>Each</i>
24DV-2U	Video Patchbay - 2U Panel With 24 x DVJB-W Dual Jacks		2 \$1,880.00 <i>Each</i>
24DVS-2U	* Video Patchbay - 2U Panel With 24 x DVJB-S Dual Jacks		2 \$1,880.00 <i>Each</i>
26DV-2U	Video Patchbay - 2U Panel With 26 x DVJB-W Dual Jacks		2 \$1,980.00 <i>Each</i>
26DVS-2U	* Video Patchbay - 2U Panel With 26 x DVJB-S Dual Jacks		2 \$1,980.00 <i>Each</i>
VPC003-WC	Video Patch Cable - VWPC4 Plugs, 30cm Long		2 \$31.00 <i>Each</i>
VPC005-WC	Video Patch Cable - VWPC4 Plugs, 50cm Long		2 \$31.00 <i>Each</i>
VPC01-WC	Video Patch Cable - VWPC4 Plugs, 100cm Long		2 \$33.00 <i>Each</i>

BNC Video Patch Panels

161U-JRU	1U with 16 x BCJ-JRU Recessed Double F/M BNC		2 \$383.00 <i>Each</i>
162U-JRU	2U with 32 x BCJ-JRU Recessed Double F/M BNC		2 \$947.00 <i>Each</i>

Model	Description	List
HDTV Digital Video Cables		
L-3CFW	75Ω HDTV-SDI Coaxial Cable 100m Roll	1 \$386.00 Roll
L-4.5CHD-BK	75Ω HDTV-SDI Coaxial Cable 100m Roll	1 \$338.00 Roll
L-6CHD-BK100	* High Performance HDTV / SDI Coax: 8.9mm O/D, Solid Centre Conductor, Double Shields: Foil + Braided (>93% Coverage). 100m Roll - BLACK	1 \$569.00 Roll
L-7CHD-BK100	* High Performance HDTV / SDI Coax: 10.2mm O/D, Solid Centre Conductor, Double Shields: Foil + Braided (>93% Coverage). 100m Roll - BLACK	1 \$623.00 Roll
L-8CHD-BK100	* High Performance HDTV / SDI Coax: 11.1mm O/D, Solid Centre Conductor, Double Shields: Foil + Braided (>93% Coverage). 100m Roll - BLACK	1 \$710.00 Roll
BCP-C6HD	* PRECISION: Suits L-6CHD HDTV / SDI Cable (8.9mm OD)	2 \$21.00 Each
BCP-C7HD	* PRECISION: Suits L-7CHD HDTV / SDI Cable (10.2mm OD)	2 \$17.00 Each
BCP-H31F	PRECISION: Suits L-3FWC HDTV / SDI Cable	2 \$21.00 Each
NCP-H8HD	* C-Type SOLDER Connector: Suits L-8CHD HDTV / SDI Cable (11.1mm OD)	2 \$44.00 Each
NCJ-BCJR	* C-Type to BNC CONVERTER:: Suits NCP-H8HD with L-8CHD cable	2 \$29.00 Each
TCD-67HD	Dies: BCP-C6HD & BCP-C7HD	2 \$409.00 Each

Hybrid Fibre Optic Camera Cable Assemblies Single-Mode (SMPTE 304M / 311M & ARIB BTA S-1005B)

FCC10A	* 10 Metre: Canare FCF / FCM Connectors, LF-2SM9R Cable (black)	2 \$1,733.00 Each
FCC20A	* 20 Metre: Canare FCF / FCM Connectors, LF-2SM9R Cable (black)	2 \$1,932.00 Each
FCC50A	* 50 Metre: Canare FCF / FCM Connectors, LF-2SM9R Cable (black)	2 \$2,538.00 Each
FCC100A	* 100 Metre: Canare FCF / FCM Connectors, LF-2SM9R Cable (black)	2 \$3,549.00 Each
FCC50A-WJ	* 50m cable as above but with larger 16mm O/D LF-2SM16 cable	2 \$3,080.00 Each
FCC100A-WJ	* 100m cable as above but with larger 16mm O/D LF-2SM16 cable	2 \$4,608.00 Each



Hybrid Fibre Optic Receptacle Assemblies Single-Mode (SMPTE / ARIB)

FCS015A-MR	* 1.5 Metre: Canare FCMR Connector to 2 x F/O + 6 x Electrical Lines	2 \$710.00 Each
FCS015A-FR	* 1.5 Metre: Canare FCFR Connector to 2 x F/O + 6 x Electrical Lines	2 \$920.00 Each
IU-FCM-SET	* Panel Isolation Kit - suits FCMR Panel-Mount Receptacle	2 \$32.00 Each
IU-FCF-SET	* Panel Isolation Kit - suits FCFR Panel-Mount Receptacle	2 \$32.00 Each



Hybrid Fibre Optic Splice Enclosures

FCE-2	* 4 x SC Fibre-Optic + 2 x 6-Way Electrical + 2 x Cable Inlets	2 \$814.00 Each
FCE-4	* 8 x SC Fibre-Optic + 4 x 6-Way Electrical + 4 x Cable Inlets	2 \$1,262.00 Each
FCE-6	* 12 x SC Fibre-Optic + 6 x 6-Way Electrical + 6 x Cable Inlets	2 \$1,787.00 Each

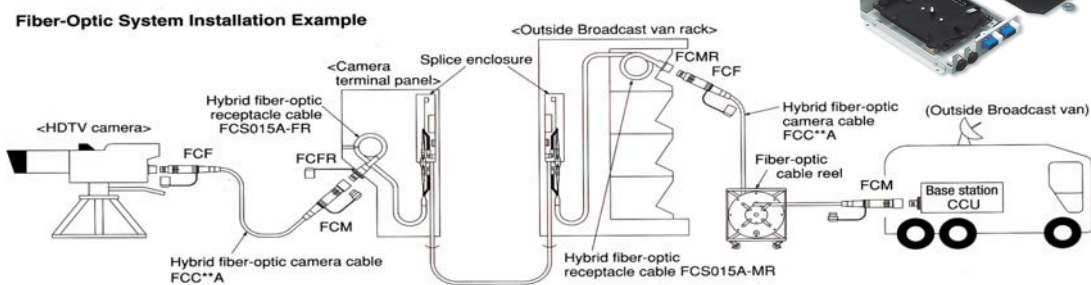

Fibre Optic Cable Checker

FCT-FCKIT	Portable Cable Checker System for hybrid camera Cables: - inc soft case, cleaning sticks & AA batteries	2 \$4,756.00 Each
ASPT-1	* Sleeve/Insert Extraction Tool for FCF/FCFR Hybrid Cable Connectors	2 \$21.00 Each
CLETOP	* CLETOP 2.5/2.0 Cleaning Sticks - 100-piece pack	2 \$559.00 Each



Model	Description	List
-------	-------------	------

Multi-Channel Fibre Optic Transmission Systems

(up to) 16 x Channels TX or RX using discrete SC Cables

161UPSB	* 1RU Powered Frame (empty): holds up to 16 x EO or OE Converter Modules with Redundant PSM	2	\$12,320.00	Each
EO-100	* HD/SDI-to-Optical Converter Module (FIXED frequency)	2	\$1,986.00	Each
OE-101	* Optical-to-HD/SDI Converter Module	2	\$1,839.00	Each
EE-100	* HD/SDI Digital Repeater Module	2	\$2,859.00	Each



Example System:

16-Channel HD/SDI -> Optical -> HD/SDI using 2 x 161UPSA
16-module frames & redundant PSU's (SC Cables NOT included).

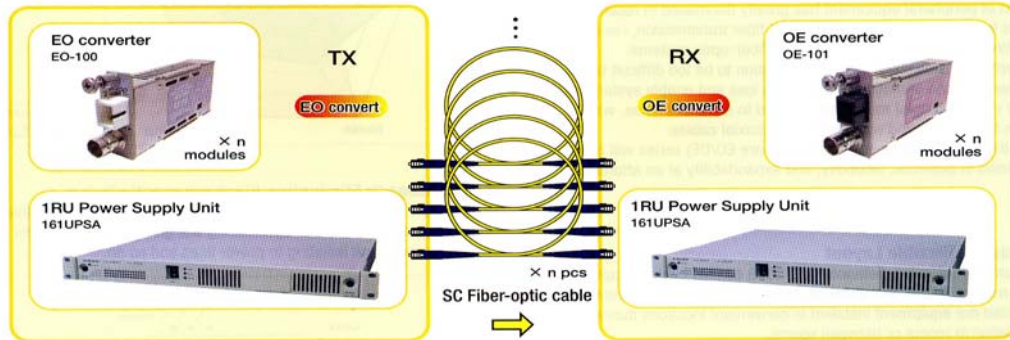

8 x Channel Bi-directional Mux / Demux System using a Single SC Fibre-Optic Cable

161UPSB	* 1RU Powered Frame (empty): for up to 8-channels of Mux / Demux	2	\$12,320.00	Each
FCWDM-8	* 8-Channel Multiplexer / Demultiplexer Module	2	\$6,160.00	Each
EO-100A-**	* HD/SDI-to-Optical Converter Module (select from 8 frequencies)	2	\$3,874.00	Each
OE-101	* Optical-to-HD/SDI Converter Module	2	\$1,839.00	Each
FS3C003-S	* Optical SC Patchcord - 300mm	2	\$34.00	Each



Fibre Optic Patch Cables

(All fitted with SC-type connectors and BellCore (blue boots))

FS3C02-S	* Single-Mode / Single (yellow) Cable - 2 metre (end-to-end)	2	\$34.00	Each
FS3C03-S	* Single-Mode / Single (yellow) Cable - 3 metre (end-to-end)	2	\$37.00	Each
FS3C05-S	* Single-Mode / Single (yellow) Cable - 5 metre (end-to-end)	2	\$40.00	Each
2FSZ3SO2-S	* Single-Mode / Dual (yellow) Cable - 2 metre + 2 x 150mm tails	2	\$71.00	Each
2FSZ3SO3-S	* Single-Mode / Dual (yellow) Cable - 3 metre + 2 x 150mm tails	2	\$74.00	Each
2FSZ3SO5-S	* Single-Mode / Dual (yellow) Cable - 5 metre + 2 x 150mm tails	2	\$79.00	Each
2FG5Z3CO2-S	* Multi-Mode (G150/125) / Dual (orange) Cable - 2m + 2 x 150mm tails	2	\$70.00	Each
2FG5Z3CO3-S	* Multi-Mode (G150/125) / Dual (orange) Cable - 3m + 2 x 150mm tails	2	\$74.00	Each
2FG5Z3CO5-S	* Multi-Mode (G150/125) / Dual (orange) Cable - 5m + 2 x 150mm tails	2	\$82.00	Each
2FG6Z3CO2-S	* Multi-Mode (G162.5/125) / Dual (orange) Cable - 2m + 2 x 150mm tails	2	\$70.00	Each
2FG6Z3CO3-S	* Multi-Mode (G162.5/125) / Dual (orange) Cable - 3m + 2 x 150mm tails	2	\$74.00	Each
2FG6Z3CO5-S	* Multi-Mode (G162.5/125) / Dual (orange) Cable - 5m + 2 x 150mm tails	2	\$82.00	Each

CAT 5e

RJC5ES-4P-100	6mm OD Multi-strand CAT 5e 100m Roll	1	\$953.00	Roll
RJC5ES-4P-200	6mm OD Multi-strand CAT 5e 200m Roll	1	\$1,906.00	Roll

Panasonic P2HD Cable Assemblies

DC30V10-SC	* Power Feed Cable 30m -CE01PS	2	\$1,039.00	Each
DC50V10-SC	* Power Feed Cable 50m-CE01PS	2	\$1,299.00	Each
DC100V10-SC	* Power Feed Cable 100m-CE01PS	2	\$1,945.00	Each
V2PCS25-SF-SC	* Power and 2BNC Bundle Cable 25m 5CFWCE	2	\$2,014.00	Each
V2PCS30-SF-SC	* Power and 2BNC Bundle Cable 30m -5CFWCE	2	\$2,224.00	Each
V2PCS50-SF-SC	* Power and 2BNC Bundle Cable 50m -5CFWCE	2	\$3,076.00	Each
V2PCS100-SF-SC	* Power and 2BNC Bundle Cable 100m -5CFWCE	2	\$5,178.00	Each
D3C0025	* 0.25m Jumper BNC Cord for SDI -SBL-SDI-SC	2	\$95.00	Each
D3C0023	* 0.23m Jumper BNC Cord for Gen Lock -SBL-SDI-SC	2	\$95.00	Each

(* = Non-stock item, ** = MOQ's may be applicable)